

DuxxBak[®] Dekk

By DuxxBak Composite Decking
A Division of Green Bay Decking, LLC

DUXXBAK DEKK WATER SHEDDING DECK SYSTEM INSTALLATION INSTRUCTIONS

DuxxBak DekkWater Shedding Deck System

- The DuxxBak Dekk Water Shedding Deck System is an innovative product designed to shed water in any environment. Properly installed, DuxxBak Dekk will provide a functional, dry underdeck area, without the moisture buildup and structural compromise associated with conventional underdeck drainage systems. Installation of this product is vastly different from our other quality offerings. Strict adherence to these installation instructions will ensure delivery of an attractive, functional system.



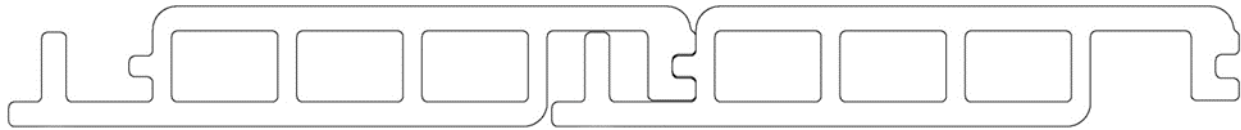

TABLE OF CONTENTS

Important Installation Tips	3
General Information	4
Product Information	4
DuxxBak Dekk Product Profiles	4
Storing and Handling	4
Sufficient Pitch	4
Substructure Framing	4
Proper Caulk and Flashing System	5
Caulk and Flashing On Masonry	5
Fasteners Installation	5
Fascia Installation	6
Special Design Concepts	6
Installation Hints	6
Final Preparation	7
Proper Endcap Selection	7
Parts of DuxxBak Dekk Board	7
Installation Guide	8
Step 1: Install The First Deck Board	8
Step 2: Install The Second and Subsequent Deck Boards	9
Step 3: Install The Final Deck Board	9
Step 4: Install Seal and Flashing	10
Step 5: Install Endcaps on Exposed Boards	11
Step 6: Install Gutters	11
Step 7: Completion	11
DuxxBak Dekk End Cap Installation On A 45 Degree Angle Deck	12
Installation of Replacement Board	13
Stair Installation	14
Care and Maintenance	14
Warranty	14
Fasteners	15
Product Features	16
List of Revisions	16

DuxxBak[®] Dekk[®]

DuxxBak Dekk WATER SHEDDING DECK SYSTEM **IMPORTANT INSTALLATION TIPS**

- If questions arise during installation for which you can find no answer, or for general product or installation questions, please call us toll-free at 1-877-804-0137.
- All composite decking will expand and contract as temperatures change. To minimize potential system failure resulting from these movements, avoid installing your decking during extreme temperatures.
- DuxxBak Dekk is designed for use as weather protection above an outdoor living area. DuxxBak Dekk is not designed or approved to be used over a temperature-controlled, enclosed living space.
- An unrestricted minimum pitch of 1/8" per foot in the direction of intended water flow (along the length of the deck board) is required.
- A gap of at least 3/16" must be provided where the deck boards meet the house or other structure. A gap of 3/16" must be provided at each side of posts or other obstructions.
- See important board-gapping information in step 2 of installation instructions, page 9.
- Use genuine DuxxBak Composite Decking screws, or equivalent.
- All fasteners must be located a minimum of 3/4" from the ends of the deck boards. Additionally, any necessary face fasteners should be placed near the deck board structural septum, but not directly through the septum. Avoid over penetration of the fastener heads.
- DuxxBak Dekk should be installed on an open structure that allows ventilation through the deck structure. If installing a ceiling below a DuxxBak Dekk, installers should defer to the ventilation requirements of the structural component manufacturer.
- As with any manufactured decking product, be aware of conditions where reflective heat buildup from "Low-E" glass may cause damage to your deck.
- No special tools are required to work with DuxxBak Composite Decking products. Typical wood-working tools are recommended.
- It is always good idea to wear personal protective equipment, such as safety glasses, hearing protection, and a dust mask when working with any construction materials.
- Composite decking is not designed to act as a structural element. Avoid placing weight bearing loads, such as roof-support columns, on top of a composite decking surface.
- Installation and care instructions & videos can also be found on our website at www.duxxbakdecking.com
- A numeric superscript is used at various locations in this document to reference a revision from V13.7. All revisions can be found on the "List of Revisions" document.

Thank you for choosing the DuxxBak Dekk Water Shedding Deck System



GENERAL INFORMATION

PRODUCT INFORMATION

DuxxBak Dekk boards have laser-engraved identification information on the board edge, including a code-compliance report number.

DuxxBak Dekk boards are made from a formulation of BioDac®, rice hulls (a rapidly renewable resource), HDPE, and other high-quality materials. Its properties are an innovative deviation from those of other manufactured-decking options. Therefore, DuxxBak Dekk has different handling and installation requirements which must be considered during planning and installation.

Typical woodworking tools are recommended. No special tools are required.

If questions arise during installation for which you can find no answer, or for general product or installation questions, please call us toll-free at 1-877-804-0137.

DUXXBAK DEKK PRODUCT PROFILES

DuxxBak Dekk Product Profiles

- DuxxBak Dekk
 - ◇ Description: 5/4" x 7-1/4"
 - ◇ Height: 1-1/4"
 - ◇ Width: **5-3/4" Coverage**
 - ◇ Lengths: 12', 16', 20' and 24'
 - ◇ Weight: Approx. 2.1 lbs./ft.
- DuxxBak Dekk End Cap (Right & Left)
 - ◇ Height: 1-1/4"
 - ◇ Width: 5-3/4"
 - ◇ Weight: Approx. 0.06 lbs.



To determine end cap direction for DuxxBak Dekk or I.Dekk® T&G: While looking at the open end of installed deck boards, simply refer to the side of the deck at which you began installation—LEFT or RIGHT. (See illustration on pg 7).

- Fascia Board
 - ◇ Height: 12"
 - ◇ Thickness: 7/16"
 - ◇ Length: 12'
 - ◇ Weight: Approx. 2.6 lbs./ft.



STORING & HANDLING DUXXBAK®

DuxxBak Dekk should be stored on a flat surface with supports every 48". Do not stack decking more than four units (bundles) high. Trim boards should have supports every 24", to avoid sagging, which could make proper installation challenging.

It is always a good idea to wear personal protective equipment, such as safety glasses, hearing protection, and a dust mask when working with construction materials.

SUFFICIENT PITCH

Before installing DuxxBak Dekk, be sure your deck structure has an unrestricted minimum pitch of 1/8" per foot to help shed water from the deck surface. Remember: Pitch must run lengthwise direction of the DuxxBak Dekk boards.

SUBSTRUCTURE FRAMING

Plan your deck substructure to use current framing techniques as outlined in the International Residential Code (IRC) and your local building codes.

Remember that the deck pitch must be unrestricted. The deck structure must be constructed such that the top of the structure is in plane, avoiding the introduction of a high point or a low point along the pitch of the deck.

DuxxBak Dekk is designed for installation on joists that are spaced at 24", or less, on center. Each joist longer than 6' should be installed with at least three points of attachment. If a joist is attached or supported only at each end, and is longer than 6', internal blocking must be installed at 6' intervals to stabilize the structure. The mid-joist beam or blocking will also enable the installer to bring the entire deck structure into plane.

Support blocking should be installed to support the full width of every deck board where it is cut around obstructions such as railing posts.

I.Dekk® or I.Dekk HD S4S or OPTIMA® Dekk Square Edge deck boards can be used as stair treads, to complement the DuxxBak Dekk system.

PROPER CAULK AND FLASHING SYSTEM

Successful installation of your deck is dependent on proper sealing and flashing at the surfaces where the deck meets your home or other structure. Water must be properly directed to avoid leakage.

- **Sealants:** Use LEXEL Adhesive Sealant or equivalent to form water barriers where a sealant is recommended.
- **Sealing Tape:** Use the best sealing tape available from your supplier to form a waterproofing barrier at the point where the flashing and house wrap are joined.
- **Butyl Tape:** Use butyl tape to form a waterproofing barrier at those points where structural objects penetrate the deck, to form a waterproofing seal.
- **Flashing:** Use exterior-grade vinyl, coated aluminum, or galvanized flashing rated for contact with your deck's structural components.

CAULK AND FLASHING ON MASONRY

Counterflashing is a piece of metal or vinyl designed to shed water away from the wall of a building, and is an essential step when installing DuxxBak No Drip Through Decking on a deck structure that is attached to a masonry wall where traditional flashing cannot be achieved. This approved method of counterflashing for masonry walls is called Reglet counterflashing.

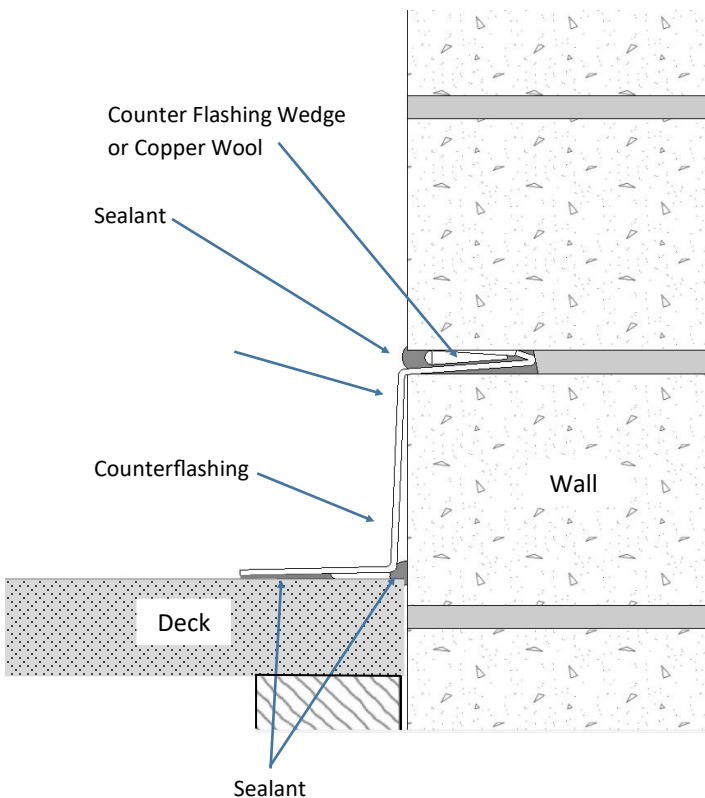

Reglet Counterflashing is done by using a masonry saw or grinder to cut a 3/4" to 1-1/2" Reglet in the masonry. The Reglet can be cut into a joint, or into the stone itself. The flashing is then inserted into the Reglet, and held in place with a lead wedge or copper wool, or flashing wedge. A bead of caulk is then used to fill the reglet opening. Sealant should also be installed where the deck meets the wall, and where the flashing meets the deck boards.

FASTENERS INSTALLATION



General Notes

- DuxxBak Composite Decking screws, or equivalent, are recommended.
- Avoid the use of "composite screws"—those with reverse threads near the top end of the screw—as the reverse threads displace too much material, compromising the attachment of decking to structure. Ideally, a screw with a smooth (non-threaded) shaft at its top should be used.
- Make sure the fastener coating is approved for use in your structural material.
- Stainless steel screws are recommended for use near salt water.
- Additional fastener information can be found on the Fasteners page at end of this instruction manual.

DuxxBak Dekk

- Use 1-1/4" (or longer) DuxxBak Composite Decking screws to attach the decking through the fastening wing. Insert fasteners at an angle of 55-60 degrees. (Please see illustration, above)
- Use 2-1/4" (or longer) DuxxBak Composite Decking screws to attach decking when it is necessary to insert a fastener through the face of the deck board.

I.Dekk® Fascia

- Use 1-1/2" (or longer) DuxxBak Composite Decking screws to attach fascia.
- Use a minimum of three fasteners every 12" to secure the connection.

DuxxBak Dekk End Cap

- End caps can be secured using an adhesive sealant applied to the legs of each cap before insertion.
- Alternatively, a 1/8" hole may be drilled through the underside of the decking and through 2 legs of the end cap, into which a #6 x 1" truss-head or pan-head screw can be inserted.

FASCIA INSTALLATION

Install fascia to the outer joists (rim joists and end joists) of the deck substructure.

- Use a minimum of three evenly spaced screws every 12" (or two every 12" if the fascia has been ripped to 6" or less).
- End-to-end "butt-joints" must have a 3/16" minimum gap to allow for expansion and contraction with variations in temperature. There are several methods of concealing the gaps in fascia butt-joints, as follow:
 - ◇ Leave a wider gap and cover with a ripped piece of fascia installed vertically. Be sure the screws that attach the cover do not limit movement of the boards being butted together (see below illustration).
 - ◇ Apply a dark wood stain (similar to the color of the fascia) to the joist 1"-2" in each direction from where the butt-joint will lie. As the fascia opens and closes, the wood stain will render the gap practically invisible.
- The same 3/16" gap should be allowed at corners to allow for expansion and contraction. A corner molding can be ripped from a spare piece of decking or post sleeve. This cover should only be attached through one side to allow for expansion and contraction. (Please see illustration below) Alternatively, the wood-stain process described above can be used here to conceal the required gap (see below illustration).

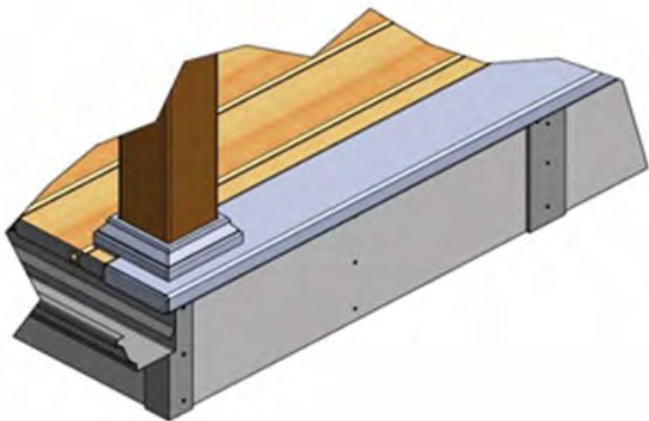

SPECIAL DESIGN CONCEPTS

Special design concepts may require that you and your designer consider how to best implement those concepts, prior to construction, to avoid problems during or after installation. The following may be such situations:

- DuxxBak Dekk is available in 12', 16', 20', and 24' lengths. Custom lengths are available subject to restrictions. Design concepts must be considered if conditions require longer spans to assure that water can properly shed from the deck.
- Deck boards should not be butted end to end, as this would compromise the watertight integrity of the DuxxBak Dekk installation.
- Contact DuxxBak Composite Decking for technical guidance for special design considerations relative to your specific project.

INSTALLATION HINTS

- Lay the deck boards out prior to installation to determine the most pleasing effect of the grain pattern.
- It is best to mark, cut, and install deck boards when they are all at similar temperature.
- Cut boards to length, *after* installation, allowing a 1-7/16" overhang past the deck structure. This will allow for the installation of a 7/16" fascia board and a final overhang of 1".
- Fascia may be installed before or after decking installation.
- A gutter apron (drip edge) should be installed on top of the outermost framing member, or fascia, to divert drainage away from the deck structure and fascia, and to prevent water from wicking back on the underside of deck boards. A bead of adhesive sealant should be installed between the deck boards and the top of the apron.
- It is possible to conceal the heads of GBD trim head screws in both decking and trim boards. Simply drive the screws just below the surface of the board. Then, gather the material (which has been displaced by the screw) on top of the screw head, and tap with a hammer.

FINAL PREPARATION

Here are a few final steps to take before beginning actual installation of the DuxxBak Dekk deck boards.

Step 1: Determine Your Starting Point

Determine which side of the substructure will be the starting point for your deck. If attaching to an inside corner of a house, start on the end of the deck away from the house, and work toward the house. For a deck attached only at one edge, you can choose either side as a starting point. For the purposes of this installation guide, we'll assume we're working with an inside-corner deck, and we'll start the decking on the left side as we are looking at the back of the house from the rear yard.

Step 2: Assure most desired appearance

Lay the deck boards out on the structure, and look from different perspectives, to determine how the deck will best show its aesthetic features.

Step 3: Prepare for flashing

If possible, remove the bottom course of siding, to ease installation of flashing & sealant as decking installation progresses. Be sure to mark each piece of siding so that it can be reinstalled in the same place from which it was removed.

PROPER ENDCAP SELECTION

To determine end cap direction for DuxxBak Dekk or I.Dekk T&G: While looking at the open end of the installed deck boards, simply refer to the side of the deck at which you began installation—Left or Right.

Right End Cap needed.



Left End Cap needed.



Parts of a DuxxBak Dekk Board

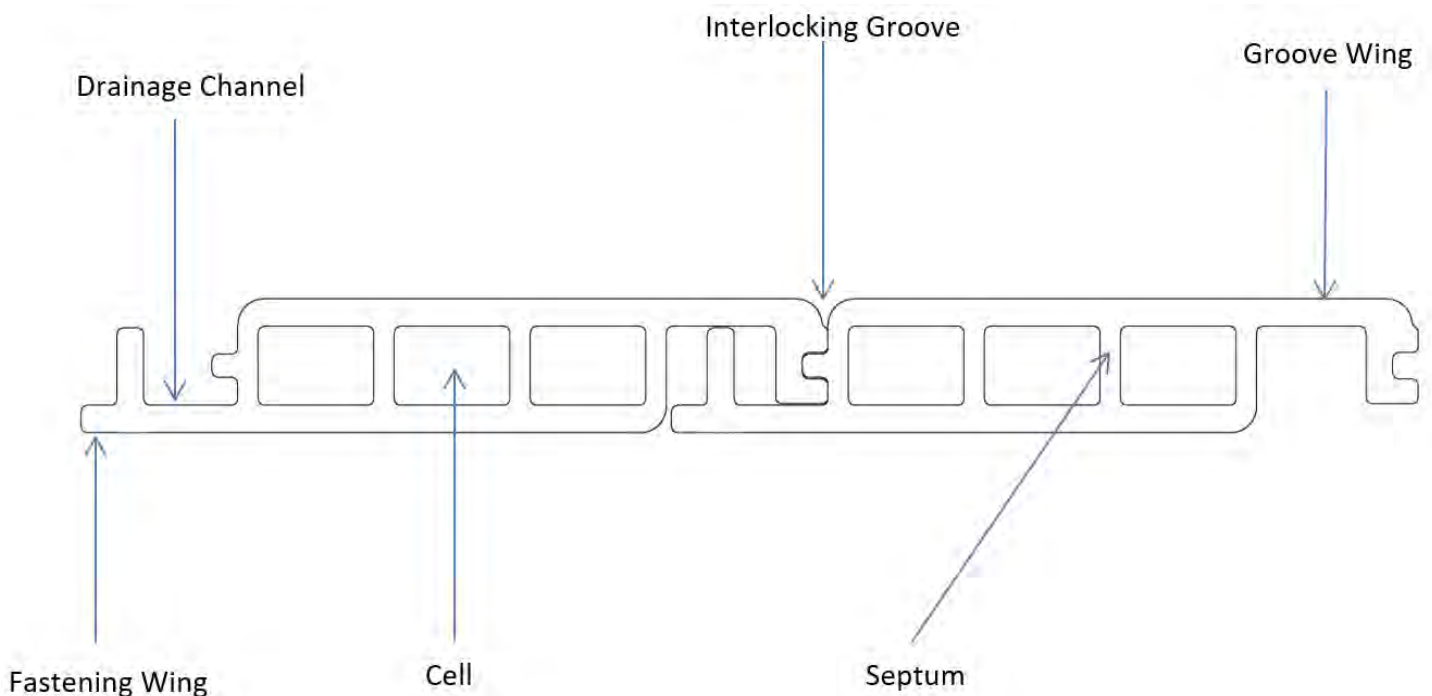

Installation Guide

Step 1: Install the first deck board

Cut the entire groove wing (1-9/16" cut) away from the first board to leave a smooth outer surface. A sander or router can be used to make the cut edge more uniform in appearance, and to round over the cut edge. (see Fg1)



Position the first board on the deck with the fastening wing to the right, with the board overhanging the edge of the structure 1 7/16" (or past the installed fascia board 1").

(Not shown in these illustrations is a recommended gutter shroud, or drip edge, which should be installed between the deck boards and the outermost structural members or fascia).

A 3/16" gap must be allowed where the end of the board meets the house, as well at any point where the deck board meets an abutment.

Notch the first and second boards, if necessary, to allow for any obstruction that will penetrate the decking surface, such as wooden railing posts. Cut the notches to allow for a clearance of 3/16" on all sides of obstructions.

Before installing the first and all subsequent DuxxBak Dekk boards, a bead of sealant (LEXEL is recommended) should be installed on top of the outermost structural members (or on top of the gutter shroud) to act as a water-stop to prevent drainage from wicking back on the underside of the deck board.¹²

After notching the second board to allow penetration of obstructions, place a continuous bead of sealant into the entire length of the interlocking groove of the second board, to prevent water penetration into the now-interrupted drainage channel below. Because the railing post will interrupt the channel, any water entering the channel could become trapped without introduction of sealant in the interlocking groove. (See Fg2)

Step 1: (continued)



Note: If there are no obstructions, such as wooden railing posts, there is no need to insert sealant in the interlocking groove between the courses.

Assure that the first deck board is properly positioned and is square to the structure.

Secure the deck board to the joists by inserting one 2 1/4" (or longer) trim head screw through the face of the board at each joist, with the screw being placed near a septum of the deck board to take advantage of the points of highest strength. Set the screw heads just below the top surface of the board to avoid pullout, and to partially conceal the screw head.

Complete the installation of the first board by inserting a 1-1/4" (or longer) trim screw through the fastening wing at each joist. Insert the screw at ≥ 55 degree angle. (See Fg3)

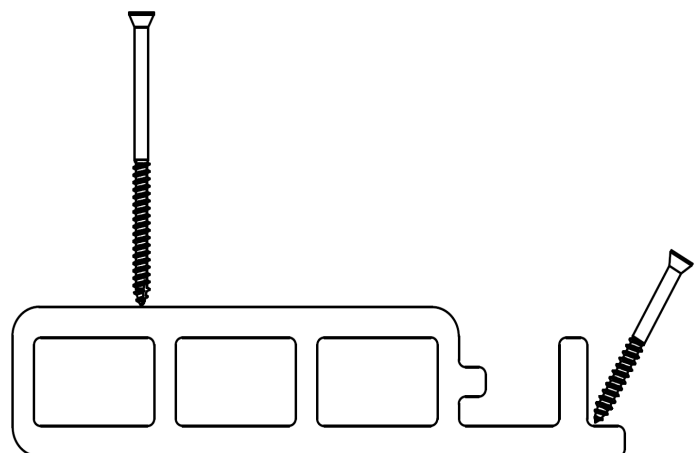

Fg3

Installation Guide (cont'd)

Step 2: Install the second and subsequent deck boards.

With the first and each subsequent board, insert a bead of sealant onto the end joist, under where the board will be installed closest to the house. (See Fg4)



Fg4



Fg5

And apply a generous dollop of sealant into the drainage channel, closest to the house, to prevent wind-driven rain from being blown backward through the channel toward the house. (See Fg5) This dollop should also act as a water-stop, compressed between the deck boards as they are being installed.

Position the second and subsequent boards by engaging the interlocking grooves of each board to lock the boards together, allowing a minimum 3/16" from the board ends to the wall.

Using a 1/32" gapping tool (typical credit card thickness), secure each board using the prescribed fasteners (See Fg6). Do not introduce a gap between deck boards that are to be sealed at the interlocking groove to prevent water penetration because of a drainage channel interruption. (You may use any gapping mechanism that measures 1/32" [.03" or 1 mm] to introduce this gap). Do not allow the gapping tool to drop between the interlocking groove interface. GBD recommends Perfect Level Reuseable Crosses.

NOTE: For installations over a pre-existing Pressure Treated or a metal structure or if the air temperature at time of installation is 80°F or greater, the introduction of a gap between the boards is not recommended.

Step 2: (continued)



Fg6

Note: The gap between deck boards will allow the deck structure to move without compromising the integrity of the deck surface.

Notch each subsequent board as necessary to allow for obstructions that may penetrate the deck substructure at the point where the board is being installed. Remember to install support blocking to ensure rigidity across the deck surface where boards have been notched.

Allow for a clearance of 3/16" on all sides of posts or other structure obstructions when installing the deck board.

And once again, at any point where an obstruction interferes with the flow of water through the channel, place a continuous bead of sealant in the entire length of the interlocking groove so that water will not find its way through the deck surface, into the drainage channel, where it may become trapped. (See Fg2, page 8)

Step 3: Install the final deck board.

Measure the area to be covered by the final deck board.

If the final board will be against the house, rip the board to at least 3/16" less than the distance to the house.

If the final board will overhang the deck, rip the board back to a septum to overhang the fascia an acceptable distance. As in preparation of the first board, clean up the ripped edge using a sander or router.

Installation Guide (cont'd)

Step 3: (continued)

Notch the board as necessary to allow for obstructions that may penetrate the deck substructure at the point where the board is being installed. Allow for a clearance of 3/16" on all sides of posts or other structure obstructions when installing the deck board. Be sure that support blocking is installed to support the deck board where notched around obstructions.

As with all obstruction-based notches, place a continuous bead of sealant in the entire length of the interlocking groove if the board seam will intersect an obstruction, to assure that water will not find its way through the deck to the surface below.

Place a bead of sealant along any joist where the deck board will rest, on all sides of the deck. (See Fg7)



Secure the last deck board to the joists by inserting one trim head screw through the face of the board at each joist, with the fastener being placed near a septum of the deck board to take advantage of the points of strength. Assure that the screw heads are seated just below the top surface of the board. (See Fg8)

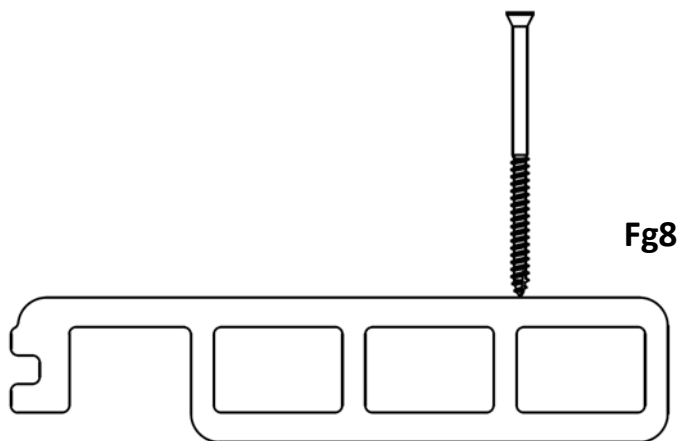

Step 4: Install seal and flash

Cut and dry-fit a piece of corrosion-resistant flashing to be installed behind the house-wrap membrane and on top of the decking. The flashing should be bent so that when installed it will naturally compress against the wall and the deck, and will shed water away from the house.

Set the flashing aside until the sealant, described below, is in place.

Place a generous, continuous bead of sealant on top of the DuxxBak Dekk boards approximately 3/4" away from the house. This sealant will create a barrier to keep wind-driven water from being blown back underneath the flashing. (See

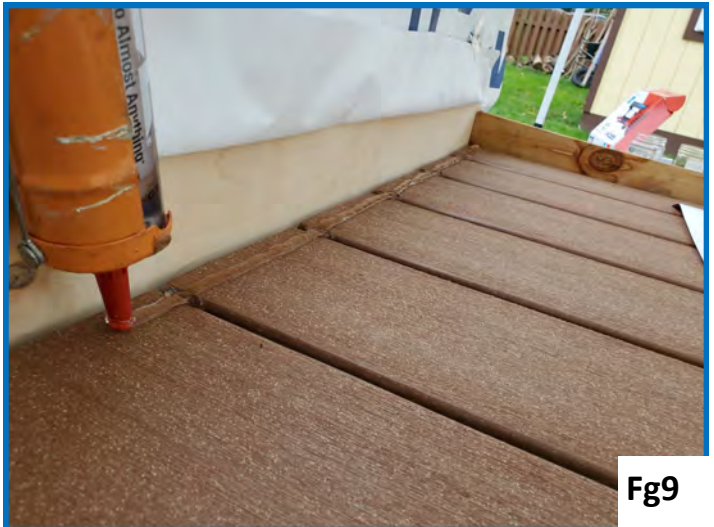

Install your pre-bent flashing at the house-to-deck connection, holding the flashing tight against the house and sliding it down onto the decking, thereby compressing the sealant installed in the previous step. Be sure that a continuous seal is formed between the flashing and the decking. (See Fg10)

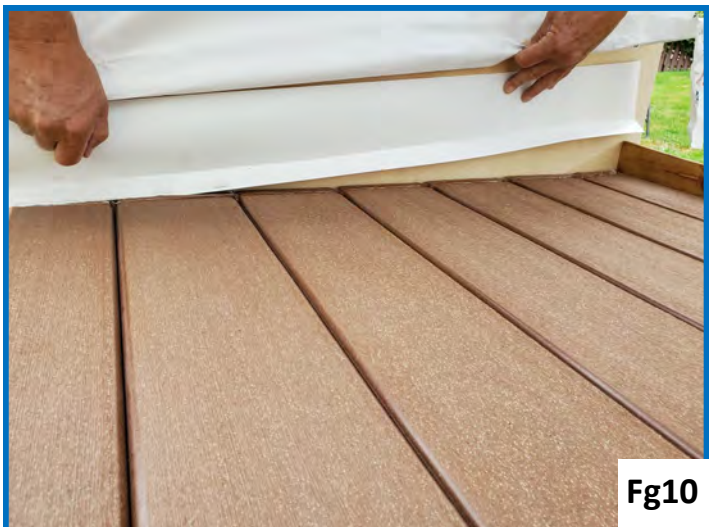

Installation Guide (cont'd)

Step 4: (continued)

Secure the flashing to the wall behind the house wrap, using a roofing nail, staple, or other appropriate fastener.

Secure the house wrap to the face of the flashing using an appropriate sealing tape. (See Fg11)



Fg11

Install or reinstall siding if it has been removed for the deck installation.

Install waterproofing butyl tape to the deck board (7/8") and obstruction at all locations where an obstruction penetrates the deck, so that water does not find its way through the deck to the area below. (See Fg12)



Fg12

Step 4: (continued)

The waterproofing butyl tape will be concealed by the post sleeve and base trim when the rail system is installed. (See Fg13)

If the railing posts are not sleeved, a trim piece can be created to conceal the butyl tape. Be sure to only fasten the trim piece to the wood post, and not to or through the decking.



Fg13

If installing structural railing posts,

- Adhere to post manufacturer's installation guidance.
- Seal interlocking groove if fastener penetrates through drainage channel (Step 1, page 8)
- Apply a generous amount of Lexel (or equivalent) around base of post and around each fastener head to prevent water penetration.

Step 5: Install end caps to exposed board ends

Install the appropriate end caps, detailed on page 7.

Insert the end cap with the drain slots down and the arrow pointing up.

End caps can be secured using an adhesive sealant applied to the legs of each cap before insertion. Alternatively, a 1/8" hole may be drilled through the underside of the decking and through 2 legs of the end cap, into which a #6 x 1" truss-head or pan-head screw can be inserted.

Step 6: Install gutters

Install system per your design concept.

Step 7: Completion

Install rail system to assure the safety of those who will use your deck.

Enjoy your new deck!!!

DuxxBak Dekk End Cap Placement On A 45 Degree Angle¹⁵

End Caps for the GBD products are primarily designed for square end applications. Occasionally, it is necessary to install an end cap on a DuxxBak installation that is at 45° angle. The following information will allow easy and attractive application of end caps into a 45° angle application. Please note, this will require 2 (two) end caps per board.

Step 1:

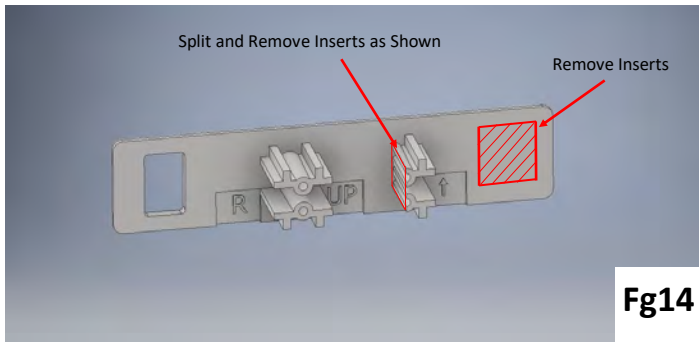

Fg14

Cut your first end cap as shown below. Fg14

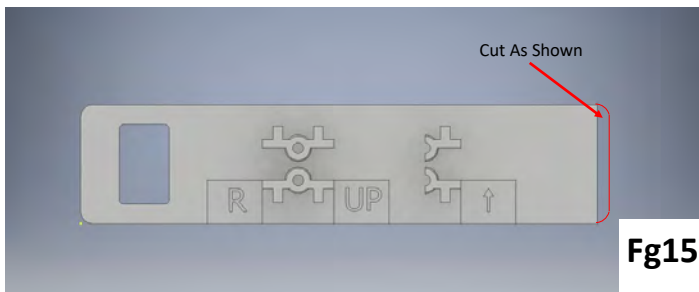

Fg15

Step 2:

Remove the filleted edge of the end cap as shown. Fg15

Step 3:

Position the first end cap while being sure to align the hole of the end cap with the drainage channel of the deck board. Use LEXEL brand adhesive or equivalent to secure the end cap. (See Fg16)

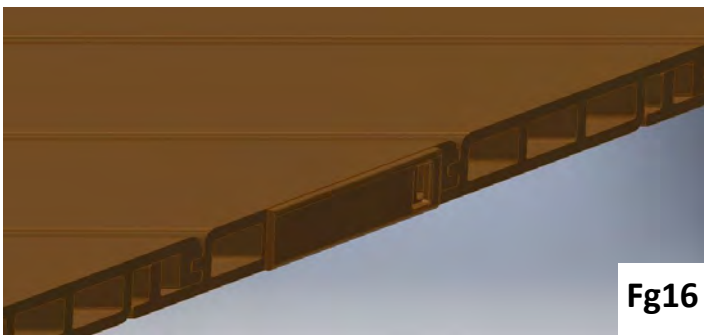

Fg16

Step 4:

Cut the second end cap as shown below. Fg17

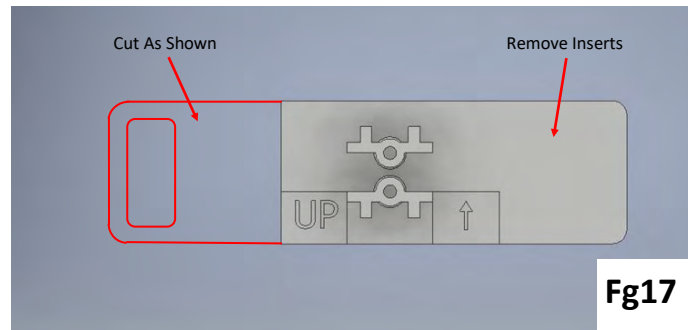

Fg17

Step 5:

Position the second end cap as shown and mark where the cap must be cut to sit flush with the first. Fg18



Fg18

Step 6:

Cut the second end cap and insert it into the end of the DuxxBak board. Use LEXEL brand adhesive or equivalent to better secure the end cap if necessary. When done properly, only a small seam will be visible where the two end caps meet. Fg19

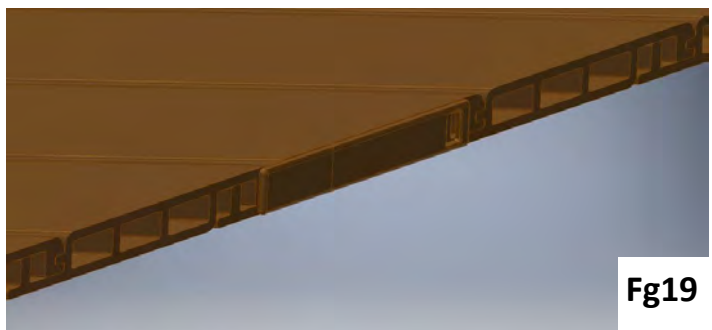

Fg19

Step 6:

Repeat this process for the remaining boards. See Fg20

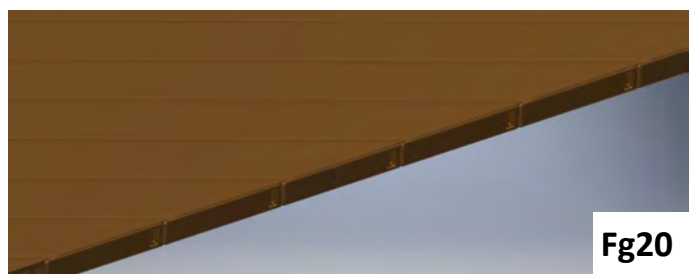

Fg20

DuxxBak Dekk Replacement Board Guide

Step 1:

Determine the number of DuxxBak dekk board(s) that must be replaced. If replacing more than one board, the DuxxBak Replacement Board Guide will only apply to the last board installed. All other adjacent boards will be replaced in accordance with the normal installation guidelines, above.

Step 2:

If you are replacing more than one board, remove the boards in the opposite direction of the original installation, which will allow the fasteners to be exposed for easy removal of the second and subsequent boards.

Step 3:

Place a chalk line or other mark along the length of the board to be removed as shown (see Fig 21), near the groove edge of the board as shown (see Fig 22).

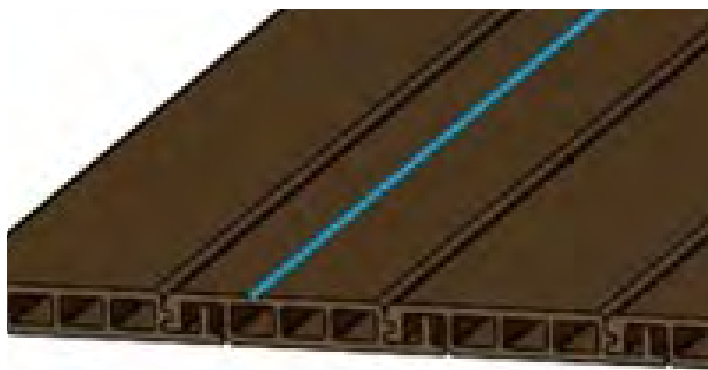
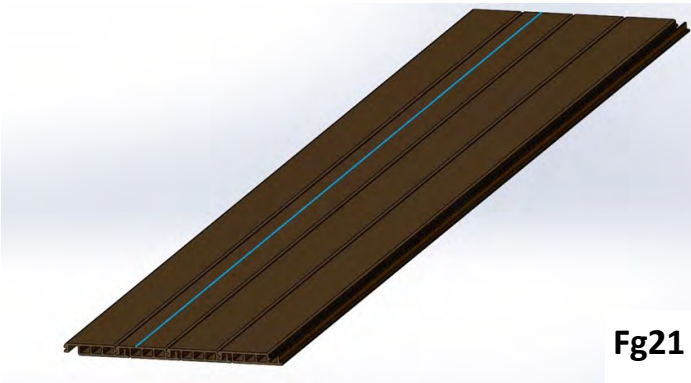

Step 4:

Using a circular saw set to a depth of 1 1/4", cut the length of the board to divide the board into two pieces. Avoid cutting into the structural component beneath the board. It may be necessary to use an oscillating tool or other tool that can work in close quarters to complete the cut near a wall or other obstruction.

Step 5:

After the board has been separated into two sections, maneuver the unfastened groove section of the board out of its position and discard. Some effort may be necessary to remove the section.

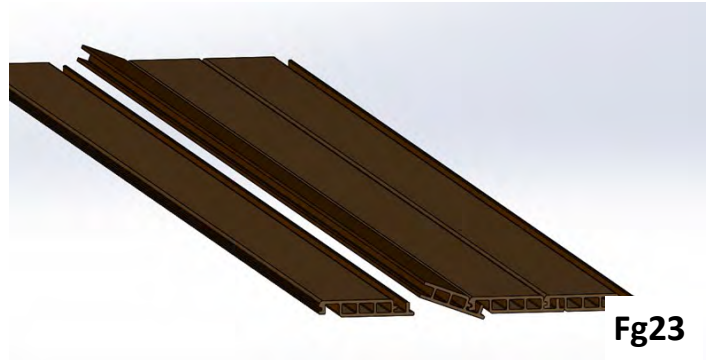

Step 6:

After the loose section has been removed, the remaining secured section can be removed by using a pry bar to lift at each joist to break the fastening wing at the points where its fasteners are located (see Fig23). The fasteners can then be removed using a reciprocating saw or oscillating tool equipped with the appropriate blade, using caution to not damage adjacent decking.

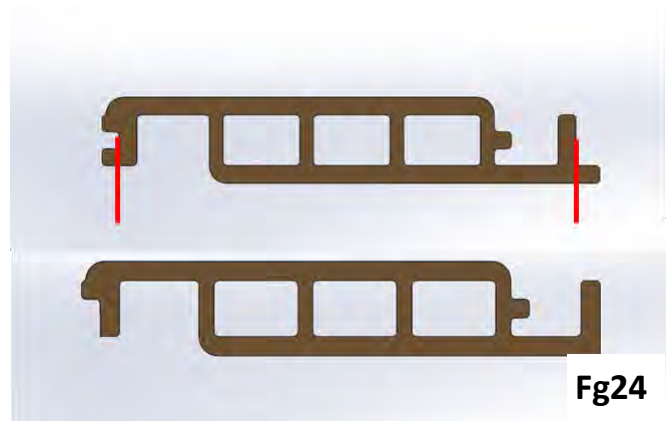

Step 7:

To prepare the new board for installation, cut away the fastening wing along the entire length of the board. Also cut away the bottom lip of the groove along the entire length of the board (see Fig24). Note that if more than one deck board is being replaced, only the last one to be installed will have to be modified.

DuxxBak Dekk Replacement Board Guide (cont'd)

Step 8:

Prepare the substructure to accept the replacement board or boards. Assure that there are no interference points.

- Place a bead of sealant on the joists where the ends of the deck boards will rest (See Fg 4 on Page 9). Assure that all points of potential water entry are properly sealed as the board replacement proceeds.
- Apply a generous dollop of sealant into the drainage channel, closest to the house, to prevent wind-driven rain from being blown backward through the channel toward the house (see Fg 5 on Page 9)
- Position the prepared deck board and secure it to the joists by inserting two trim head screws through the face of the board at each joist. Assure that the fasteners are placed near the septum of the deck board to take advantage of the points of strength. Set the screw heads just below the top surface of the board to avoid pullout, and to partially conceal the screw head.

STAIR INSTALLATION

Use I.Dekk or I.Dekk HD S4S or OPTIMA Dekk boards for the construction of stair treads for a safe installation. Use appropriate fastener as for each product per the Fastener Page.

Stair tread installation should be made on stair stringers that are no more than 12" on center.

Leave a 3/16" gap between the stair tread boards.

Install according to local codes and acceptable construction

CARE AND MAINTENANCE

Occasional cleaning will help to keep your deck looking fresh. A nylon bristle brush or broom will make the task easier.

A pressure washer with a fan tip may be carefully used to clean your deck if it is guided along in the direction of the grain at a consistent height above the deck. A Water-Broom can be used to assure even coverage and a consistent result. Always test a small area to assure that the surface texture is not damaged. Always follow safety precautions.

Although your DuxxBak Dekk Water Shedding Deck System is durable, care should be taken to avoid scratching. If scratches appear in brushed-surface DuxxBak®, it is possible to

carefully draw a stainless steel brush across the scratches in the direction of the grain to remove or reduce the scratches. Always test a small area before proceeding. (Do not use a wire brush on OPTIMA-finish DuxxBak®).

Many household spills can be removed with an all-purpose household cleaner, concentrated dish soap, laundry detergent, degreaser, or deck cleaner. Fresh spills are more easily removed, and a nylon bristle brush will help achieve the best results. Always test a small area before proceeding.

Mold and mildew that may form on the surface of your deck are environmentally generated and will not damage your deck. These can generally be removed with cleaners that are designed to remove mold and mildew along with the use of a pressure washer and nylon bristle brush as described above. Always test a small area before proceeding.

Always make necessary repairs to maintain a safe and enjoyable deck.

WARRANTY

Your DuxxBak Dekk Water Shedding Deck System comes with a lifetime limited warranty that provides coverage against splintering and splitting, rot and decay, and termite damage.

Your deck is designed to shed water and will keep the under deck area dry when properly installed.

Every material expands and contracts with temperature variations, and engineered decking is no exception. Avoid potential problems by allowing time for proper acclimation of your decking to local temperatures prior to installation. Expansion and contraction is not a product defect and is not covered under the DuxxBak Dekk Water Shedding Deck System warranty.

You will find the complete Warranty Agreement and Warranty Registration at www.duxxbakdecking.com.

It is the responsibility of the Homeowner to register the warranty for your new deck when the deck has been completed.¹⁶

Fasteners

Product Profiles

	DuxxBak Dekk	IDekk IDekk HD T&G	IDekk IDekk HD S4S	Feature Strip Perimeter Strip	OPTIMA Dekk	OPTIMA Dekk LT	COMMERCIALDekk	Fascia
Coated Screws for Engineered Profiles	DuxxBak Composite Decking Trim Head Screws-Coated www.duxxbakdecking.com	#7 x 2-1/2" (or longer)	#7 x 2-1/2" (or longer)	#7 x 3" (or longer)	N/A	N/A	#7 x 3" (or longer)	#7 x 1-5/8" (or longer)
Engineered Profiles	GRK FIN/Trim Trim Head Screw www.gkfasteners.com	#8 x 2-1/2" (or longer)	#8 x 2-1/2" (or longer)	#8 x 3" (or longer)	N/A	N/A	#8 x 3" (or longer)	#8 x 1-1/4" (or longer)
Stainless Screws for Engineered Profiles	GRK PHEINOX FIN/TRIM Trim Head Screw www.gkfasteners.com	#8 x 2-1/2" (or longer)	#8 x 2-1/2" (or longer)	#8 x 3" (or longer)	N/A	N/A	#8 x 3" (or longer)	#8 x 1-1/4" (or longer)
Hidden Fastener System	DuxxBak Composite Decking Camo Clip Hidden Fastener www.duxxbakdecking.com	N/A	N/A	N/A	With grooved board	With grooved board	N/A	N/A
Coated & Stainless Composite Screws for Solid Profiles	DuxxBak Composite Decking Optima Screw Coated www.duxxbakdecking.com	N/A	N/A	N/A	#9 x 2-3/4" (or longer) Color Match Heads	#9 x 2-3/4" (or longer) Color Match Heads	N/A	#9 x 2-3/4" (or longer) Color Match Heads
	DuxxBak Composite Decking Optima Screw Coated Stainless Steel www.duxxbakdecking.com	N/A	N/A	N/A	#9 x 2-3/4" (or longer) Color Match Heads	#9 x 2-3/4" (or longer) Color Match Heads	N/A	#9 x 2-3/4" (or longer) Color Match Heads

**** Use Genuine DuxxBak Composite Decking Fasteners for premium results****

**** Don NOT use Composite screws, standard deck screws or any screw with a reverse thread near the head of the screw for ANY Engineered Profiles****

Revision V2.1 4/15/21

DuxxBak[®] Dekk

By DuxxBak Composite Decking
A Division of Green Bay Dec LLC

Product Features

- Unique water shedding board eliminates the need for a secondary drainage system
- DuxxBak Dekk profile contains inherent hidden fastener system
- Outdoor furniture can be safely stored under the deck
- Outdoor activities can continue during periods of rainfall
- Resistant to decay and mold
- Strong and durable
- Less maintenance
- Eco-friendly
- Lifetime limited warranty
- Fast, easy installation
- DuxxBak Dekk decking can be installed on joists spaced at 24"

For the most up-to-date installation instructions, please visit
www.duxxbakdecking.com

List of Revisions

When accessing the installation instructions on www.duxxbakdecking.com, clicking on the applicable revision will bring you to the details of what was revised, and why the revision was important.

2020DB13.7—Revisions to document made Oct of 2020

2021DB13.8—Revisions to document made April of 2021



1518 South Broadway
Green Bay, WI 54304
(877) 804-0137